

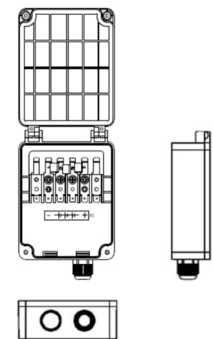

OGRE B270-J24 MONO SOLAR PANEL

OGRE solar panels are engineered for applications that require maximum power, reliability, and durability.

OGRE is field-proven in remote locations and harsh environments across the United States and Canada.

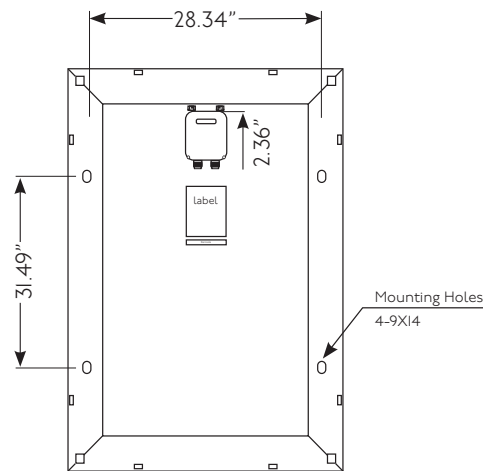
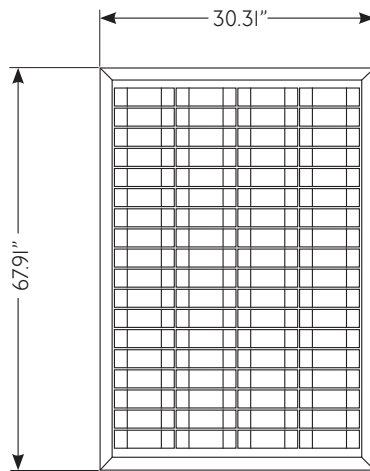

FEATURES:

- Extra heavy gauge, anodized aluminum frame is designed for ease of mounting and durability against elements like wind torque
- High efficiency back-contact monocrystalline cells
- Anti-reflective glass coating that increases sunlight absorption
- Premium cell materials ensure a long lasting module
- Power tolerance of $\pm 3\%$ means more power
- Rain tight junction box is approved for hazardous locations and includes 1/2" conduit knock-outs
- 25-year linear performance warranty
- 12-year product warranty



SPECIFICATIONS:

Max Power	270 Watts	Current	+0.06%/K
Max Power Voltage	42.55V	Cell Efficiency	17.90%
Max Power Current	6.35A	Number of Cells in Series	72
Open Circuit Voltage	49.68V	Cell Type BC	Mono
Short Circuit Current (Isc)	6.65A	Max Power Tolerance	±5%
Maximum System Voltage	600V	Weight	27.17 lbs.
Series Fuse Rating	15A	Dimensions	30.31" x 67.91" x 1.77"
Power	-0.36%/K	Thickness, with Junction Box	1.81"
Voltage	-0.36%/K	Frame Material Type	Anodized Aluminum Frame

SOLAR PANEL BRACKETS:

- Size:
 - 1100*40*40
- Fits:
 - B180-J12 + J24
 - B200-J12 + J24
 - B220-J12 + J24
 - B270-J24
 - P330-J24
 - B400-J24



25-Year Linear Performance Warranty

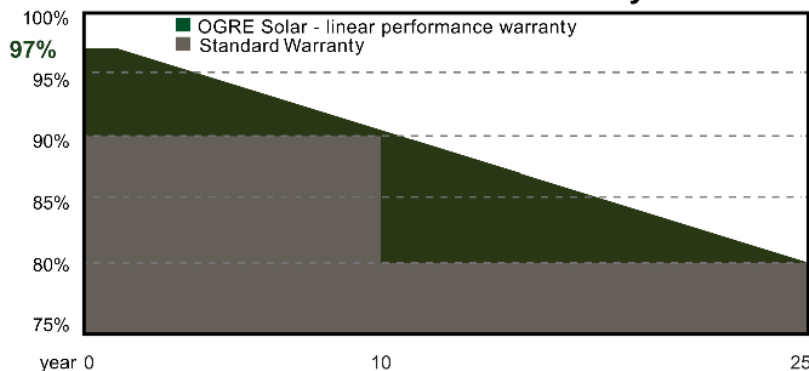

CERTIFICATIONS, RATINGS, AND TESTING:

- Class 1, Div 2, Groups A, B, C, D
- Hazardous Locations Type IP65
- T3C@Ta= -40°F to 185°F
- Manufactured in ISO9001 Factory
- Flash data (sun simulator) & EL test is performed on every panel
- Rain tight junction box is approved for hazardous locations and has four 1/2" conduit / cable fitting knock-outs